

SPECIFICATION



 70t

 47m

 63.5m

SRC700T9

SANY ROUGH TERRAIN CRANE

QUALITY CHANGES THE WORLD

It is one of the core business units in SANY Group, specializing in the development and manufacturing of high-end wheel cranes, crawler cranes and tower cranes, including the complete range of wheel cranes from 8 to 2400t, crawler cranes from 25 to 4500t and tower cranes from 6 to 185t.

三一集团旗下核心事业部，从事高端轮式起重机、履带起重机、塔式起重机系列产品的研发制造。覆盖8-2400吨全吨位轮式起重机，25-4500吨全吨位履带起重机，6-185吨塔式起重机。



SANY CRANE



SRC700T9

SANY ROUGH TERRAIN CRANE
70T LIFTING CAPACITY

A 70t rough terrain crane with five section 47m boom, featuring stronger capacity yet reduced self-weight. Key components come from name brands of reliable quality. Operator comfort is improved by brand new cab design.

一款最大起重量70吨，5节臂，全伸臂长47m的越野起重机，自重轻，性能强。核心部件均为知名供应商提供，质量稳定可靠；配备全新操纵室，驾驶、操作舒适度全面升级。



All new operator's cab

Ergonomic concept of safety and comfort

全新操纵室

操作安全、舒适、人机工程全面升级

Convenient transport

One-trailer transport at low operational cost

超便捷运输

一车整运，运营成本低

Brand-name components

DF Cummins engine/Dana transmission /Kessler axles

国际知名供应商

东风康明斯发动机/德纳变速箱/凯斯兰车桥



All New Operator's Cab

全新操纵室

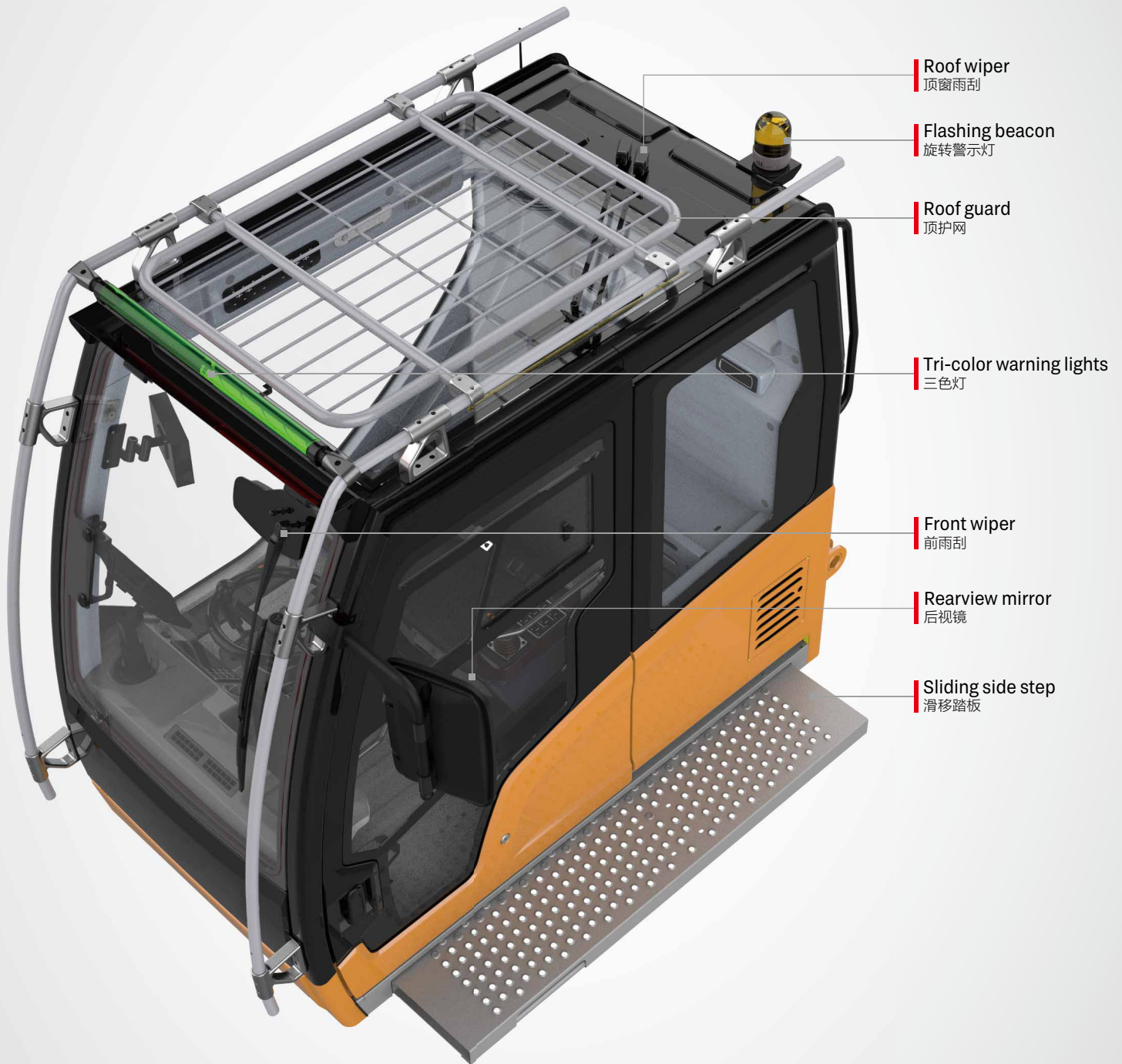

Roof wiper
顶窗雨刮

Flashing beacon
旋转警示灯

Roof guard
顶护网

Tri-color warning lights
三色灯

Front wiper
前雨刮

Rearview mirror
后视镜

Sliding side step
滑移踏板



Safety & Reliability
安全可靠



Comfort & Convenience
舒适便捷



Simplicity & Efficiency
简单高效

SPECIFICATION

Boom telescoping
pedal
主臂伸缩踏板

Joystick
手柄

Left control panel
左扶手箱控制面板

Armrest
扶手箱

Right control panel &
LMI navigation knob
右扶手箱控制面板

Rearview and
winch monitor
卷扬监视器

10.1 inch LMI screen
10.1 吋显示屏

Outrigger control
panel
支腿控制面板

Steering column
方向柱

Pedals
踏板布置

Upper control panel
辅助面板

Emergency stop
switch
急停开关

Bubble level
水平仪

Cup holder
水杯托

Joystick
手柄

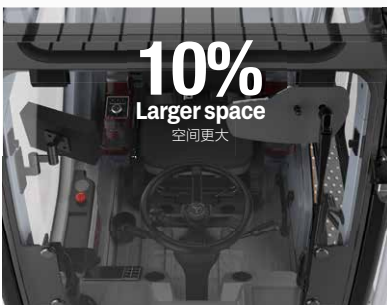
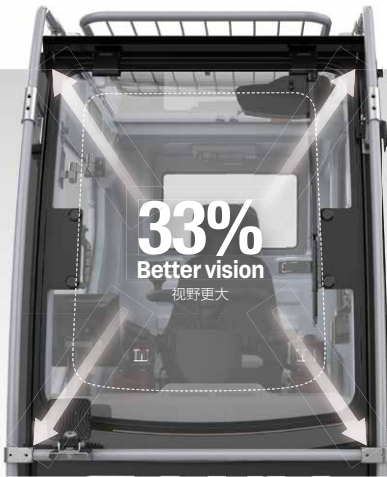

Integrating SUV genes, overall space is enlarged by 10% and forward field of vision is increased by 33%. The front windshield can be opened by 70 degrees, providing better ventilation and a second emergency exit.

融入 SUV 基因, 整体空间增大 10%, 配备超大可开合 70° 前挡风玻璃, 视野提升 33%, 增加空气对流, 并可作为快速逃生通道。



Sliding door transits between tracks when closing to make perfect thermal and acoustical insulation.
侧向变轨滑移门完美隔绝外部环境。

Getting in and out is made more convenient with the power sliding side step.
全宽电动伸缩踏板, 超大安全便利进出通道。

SPECIFICATION

Adjustable steering wheel for driving and controlling, modular control panels, and smart user interface deliver intuitive and highly efficient control.

驾控一体的方向盘、模块化控制面板、UI 智能操作界面，操作简单，为高效吊装保驾护航。



Convenient Transport

行驶运输便捷性

Four steering modes

四种转向模型

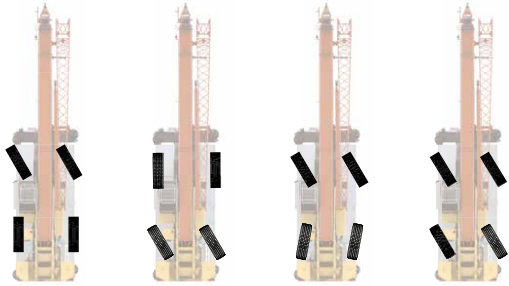

2 wheel front 前轮转向模式

2 wheel rear 后轮转向模式

4 wheel 四轮转向模式

Crab 蟹行模式



Steering control panel
转向控制面板

One-Trailer Transport

一车整运

The basic machine is transported at 49t with counterweight, jib and hooks, 3.3m wide and 3.935m high, satisfying road regulations.

主机运输尺寸为宽 3.3m, 高 3.935m, 重量为 49t (带配重、副臂和吊钩), 满足道路运输要求。



Axle Load Distribution

轴荷分布

| Items 项目 | | Weight (kg) 重量 | Load on front axle (kg) 前轴轴荷 | Load on rear axle (kg) 后轴轴荷 |
|------------------|------------------------|-------------------|---------------------------------|--------------------------------|
| Basic machine 主机 | | 49000 | 28800 | 20200 |
| Remove 移除 | Counterweight 配重 | 7600 | 3038 | -10638 |
| | Fixed jib 副臂 | 1100 | 1840 | -740 |
| | Aux. boom nose 臂尖滑轮 | 60 | 180 | -120 |
| | Main hook 主钩 (70t) | 720 | 980 | -260 |
| | Auxiliary hook 副钩 (8t) | 160 | 220 | -60 |

Carrier Frame

车架底盘



Inverted trapezoidal variable cross section frame is 5% less in weight and 10% stronger in rigidity.

倒梯形变截面车架，实现车架减重 5% 的同时，刚性提升 10%。

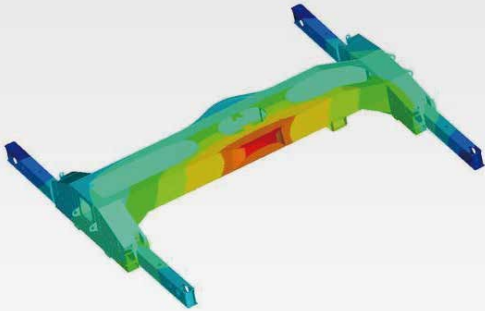

↓ 5%
Weight 重量

↑ 10%
Rigidity 刚性

Power Train

动力系统

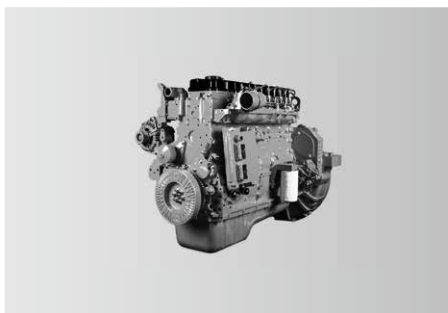

Engine

Power comes from a DF Cummins QSB6.7 inline six-cylinder water-cooled, turbocharged and intercooled off-highway diesel engine, complying with Stage III emission standard. Rated power: 178kW/2200rpm. Max. torque: 970N·m/1500rpm.

发动机

东风康明斯 QSB6.7 三阶段非道路直列六缸水冷、增压中冷柴油发动机。

额定功率 :178kW/2200rpm。

最大扭矩 :970N·m/1500rpm。

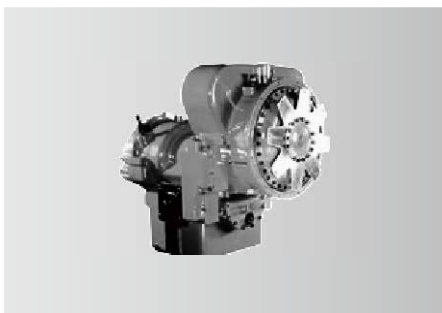

Transmission

Dana electronically controlled auto transmission features 6 speeds forward and 6 speeds reverse, wide ratio range, and smooth gearshift with reduced maintenance cost.

变速箱

德纳全自动电控变速箱,6个前进挡、6个后退挡,速比范围大,换挡平顺无冲击,维修保养成本低。

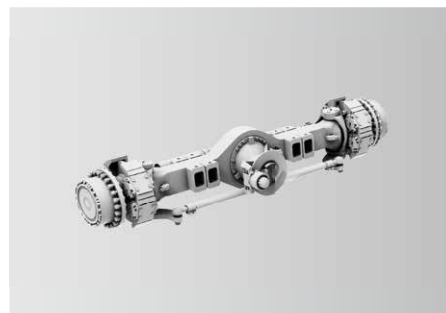

Axle and suspension

Kessler axles, both axles are driven and steered. Front axle is mounted to the frame by independent steel plate, and rear adopts oscillation cylinders with hydraulic lockout. Driving comfort and lateral stability is therefore guaranteed on rough terrains and conditions.

车桥悬挂

凯斯兰车桥,前后桥均为驱动桥和转向桥。前桥采用独立式钢板连接,后桥采用摆动支架式;液压油缸闭锁悬架系统;能适用各种恶劣工况和路面,保证车辆行驶的平顺性和侧翻稳定性,驾驶舒适。

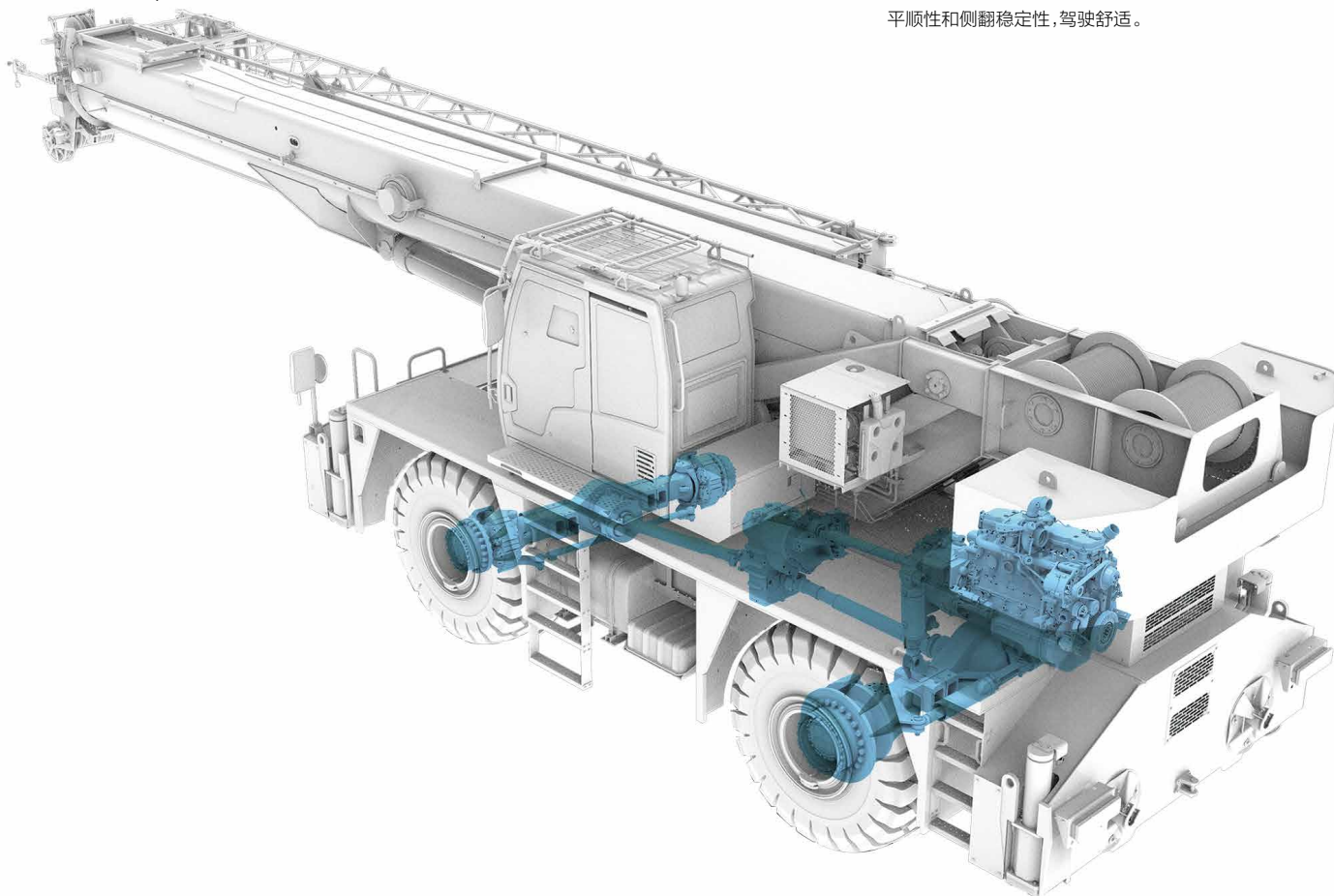

Electrical System

电气系统

Smart CAN-BUS communication system

International advanced CAN-BUS data communication network applied for display, instrument panel, I/O module, joysticks and main sensors, allowing for high-speed data transmission and quick response in less than 20ms.

Cabling

Centralized electric cabinet and heavy-duty connector applied for cabling of superstructure, convenient for maintenance; IP rating up to 67, ensuring high reliability.

Winch camera

Winch cameras equipped for monitoring its working condition and identifying rope disorder in time.

Integrated bus button panel input

Various operating states displayed by button indicator lights, and one-button multi-functional operation realizable by writing various operation modes.

智能总线通信系统

国际先进的分布式集成总线数据通信网络，显示器、显示仪表、I/O 模块、操作手柄、主要传感器等采用 CAN 总线组网，高速信息传输、响应速度小于 20ms。

电缆布线

上车电缆布线采用集中式分线盒及重载接插件，维护方便；防护等级 IP67，可靠性高。

卷扬监控系统

卷扬摄像头监视卷扬工作及及时发现乱绳的情况。

集成总线按键面板输入

可通过按键指示灯显示各种工作状态，通过写入多种操作模式实现一键多功能。



Centralized electric cabinet
集中式电控箱



Anti-two-block switch
高度限位器



Third wrap indicator
三圈保护器



Cable reel
电缆卷筒



Anemometer (optional)
风速仪 (选配)

Multi-functional screen

Large 10.1 inch HD touch screen display with all new interface. Incorporated crane setup, load charts, working conditions, working period, virtual wall, Bluetooth, radio and diagnostics with an additional navigation knob.

Precise load moment indicator

SANY independently developed LMI, accuracy of 0 ~ 5%.

高新多功能显示屏

采用 10.1 寸高清显示屏, 全新操作界面, 可实现触摸与旋钮多种方式操控。工况、力矩、发动机、变速箱、控制器 IO 点、工作时间统计等丰富的设备状态信息呈现, 集成虚拟墙、蓝牙、收音机等多种扩展功能。

精准力限器系统

三一自主研发的力矩限制器系统, 精度达 0~5%。

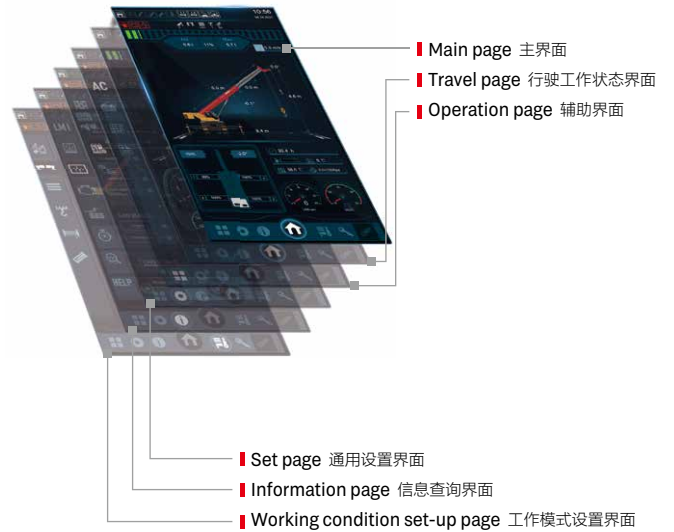

MachineLink⁺

ROOTCLOUD T-AMS Pro device comes as standard to realize GPS trajectory, machine status, maintenance management, E-fence, alarm management, and operator management on computer or mobile MachineLink+ platform, by remote control of cranes. This telematics package greatly boosts efficiency of customer fleet management and helps provide better after-sales services.

标配树根物联终端 T-AMS Pro, 通过对起重机设备的远程控制, 在电脑或移动端 MachineLink+ 平台实现轨迹回放、设备状态、维保设备、电子围栏、报警管理、操作手管理等功能, 极大提高客户设备管理效率, 提升三一售后服务能力。

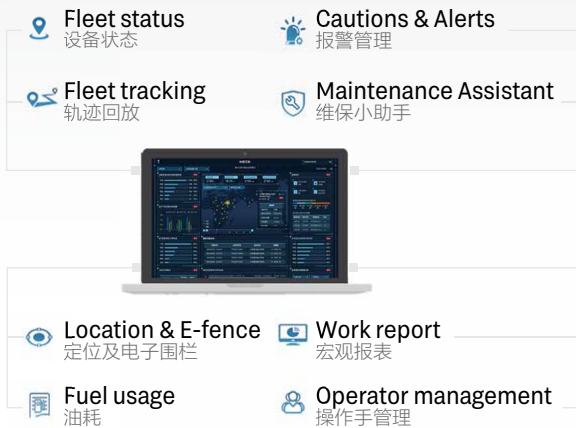

Hydraulic System

液压系统

Four boom sections extended by double cylinder with rope arranger, 2nd boom extended by cylinder I, 3rd -5th sections telescoped by cylinder II with rope pull. Synchronized telescoping of variable lengths for more applications with higher efficiency.

5 节主臂, 双缸绳排, 一号油缸和钢丝绳伸 2 节臂, 二号油缸和钢丝绳伸 3、4、5 节臂, 可实现同步伸缩, 臂长任意组合, 省时省力。



Superstructure

上车

Open-type electronically controlled load-sensing system and dynamic slewing brake system.
Electro proportional compensated passive luffing-down system applied to control the luffing speed, making luffing more reliable and stable.

Dynamic slewing brake realizing precise control of slewing speed.

Electronically controlled load-sensing hydraulic system, electronic joystick and electronic throttle, ensuring easy operation and more accurate control and millisecond-level action response speed, with min. single-rope hoisting speed 0.8m/min, and distribution difference in case of combined motions 8%.

通过开式电控负载敏感系统和动态回转制动系统；

电比例自重落幅系统控制落幅速度, 更可靠更平稳；

具备动态回转制动功能, 可实现回转速度精准控制；

电控负载敏感液压系统, 采用电手柄、电油门控制, 轻松操作的同时, 控制更精准；动作响应毫秒级速度；卷扬单绳最低速度 0.8m/min；复合动作分配误差 8%。

Chassis

下车

Steering system

A gear pump installed to supply oil for hydraulic steering, steering pressure controlled by electro-proportional relief valve, four steering modes realized by solenoid directional valve.

Suspension system

Different modes including normal driving and Pick & Carry with suspension locked, suspension to be locked when the crane is working.

Outrigger telescoping system

The electro proportional relief valve identifies pressure staging of outrigger telescoping, satisfying operation requirements under high pressure and forming protection under limited pressure.

转向系统

液压转向系统采用齿轮泵提供油源,通过电比例溢流阀精确控制转向压力,通过电磁换向阀实现前轮转向,后轮转向,全轮转向和蟹行转向共计四种转向模式。

悬挂系统

悬挂系统通过选择不同的悬挂模式可以实现正常行驶和锁定模式下的带载行驶;在起重机上车作业时能够对悬挂进行锁定。

支腿伸缩系统

支腿伸缩采用电比例溢流阀对支腿伸缩进行压力分级,既满足高压动力动作需求,也可满足限压保护功能。

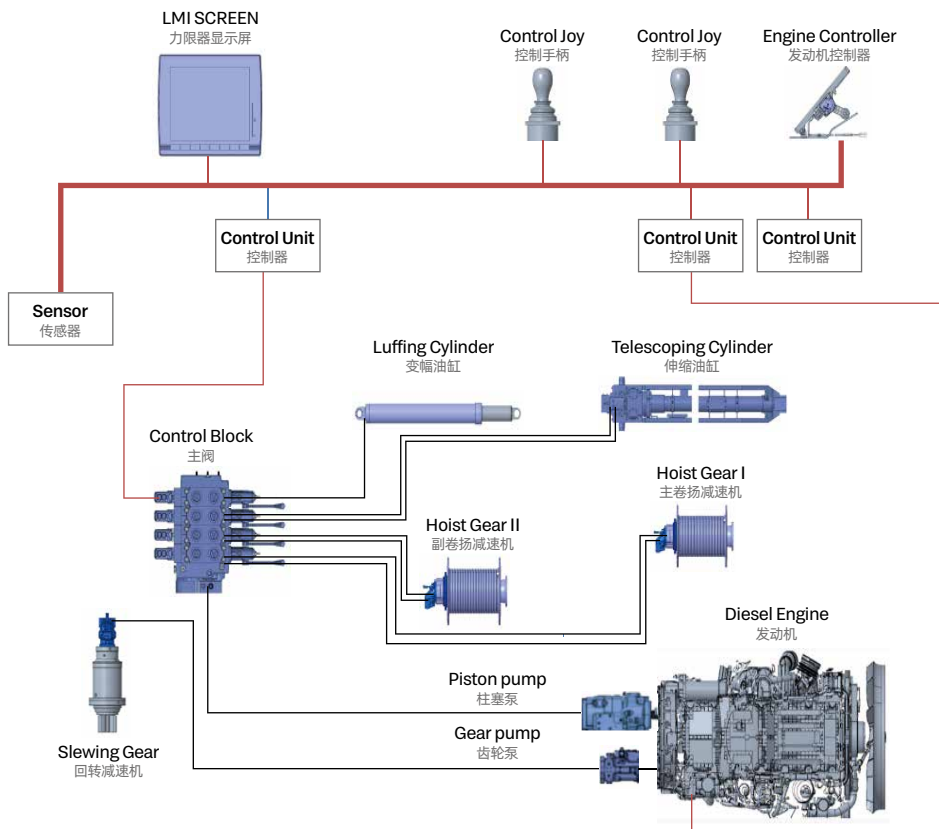

Overall Dimensions

整机尺寸

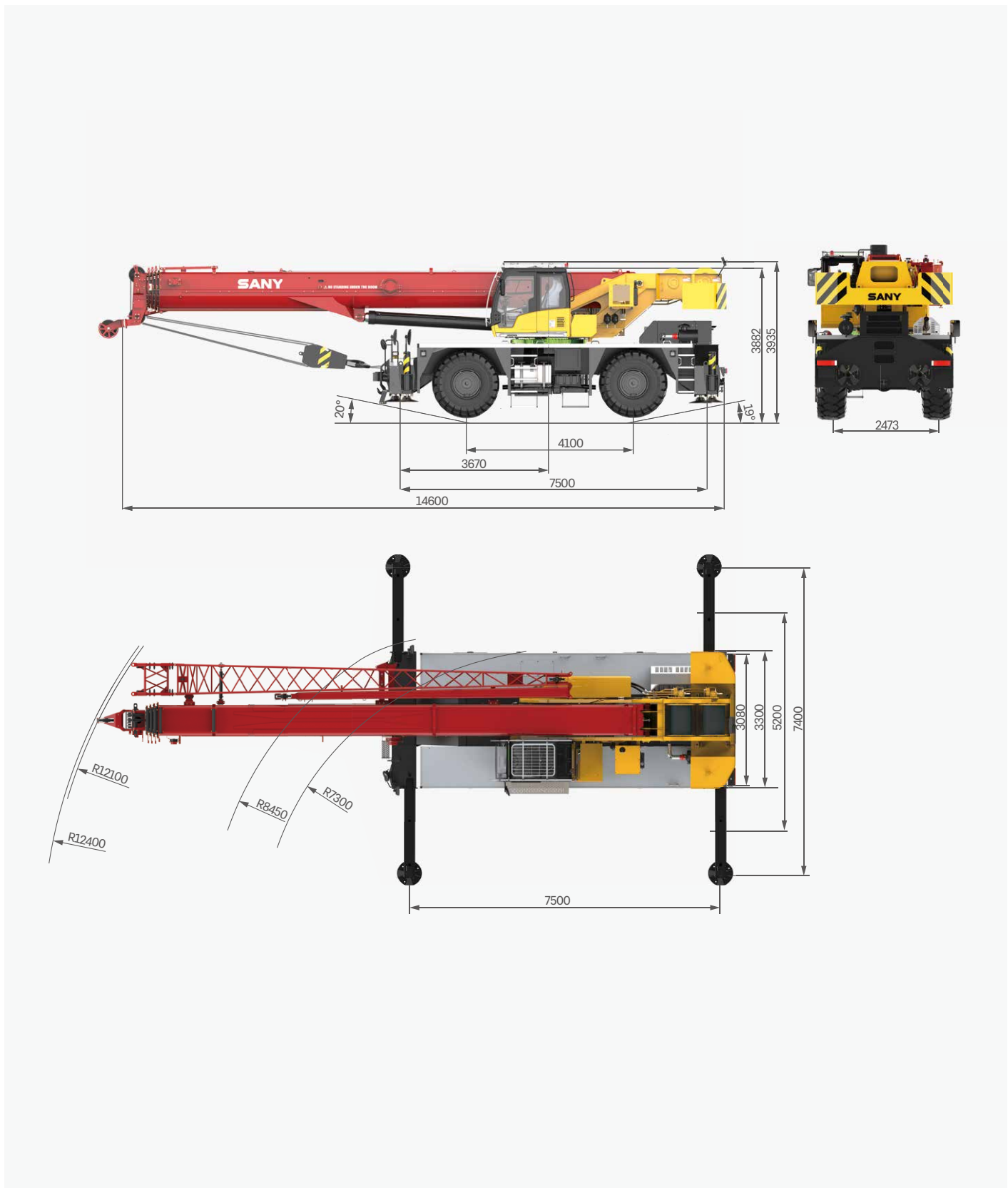

Technical Specification

整机参数

| CATEGORY 类型 | ITEM 项目 | UNIT 单位 | VALUE 参数 | |
|---|---------------------------------------|-------------------------------------|-------------------------|--------|
| CAPACITY 额定起重量 | Max. lifting capacity 最大起重量 | t | 70 | |
| WEIGHT 重量参数 | Gross weight 整机总质量 | kg | 49000 | |
| POWER 发动机参数 | Engine model 发动机型号 | - | QSB6.7 (stage III) | |
| | Max. engine power 发动机最大功率 | kW/rpm | 178/2200 | |
| | Max. engine torque 发动机最大输出扭矩 | N·m/rpm | 970/1500 | |
| DIMENSIONS 尺寸参数 | Overall length 整机全长 | mm | 14600 | |
| | Overall width 整机全宽 | mm | 3300 | |
| | Overall height 整机全高 | mm | 3935 | |
| TRAVEL 行驶参数 | Max. travel speed 最高行驶速度 | km/h | 36 | |
| | Steering radius 转弯半径 | Min.steering radius 最小转弯半径 | m | 14/7.6 |
| | Wheel formula 车轮模式 | - | 4 × 2; 4 × 4 | |
| | Min.ground clearance 最小离地间隙 | mm | 510 | |
| | Approach angle 接近角 | ° | 20 | |
| | Departure angle 离去角 | ° | 19 | |
| | Max.gradeability 最大爬坡度 | - | 75% | |
| | Fuel consumption per 100km 每 100 公里油耗 | L | 85 | |
| MAIN PERFORMANCE 主要性能参数 | Working temperature range 使用温度区间 | ℃ | -40~+46 | |
| | Min.rated lifting radius 最小额定幅度 | m | 3 | |
| | Tail slewing radius 转台尾部回转半径 | m | 4.45 | |
| | Boom sections (Qty.) 臂节数 | - | 5 | |
| | Boom shape 臂形状 | - | U shape U型 | |
| | Max.lifting moment 最大起重力矩 | Basic boom 基本臂 | kN·m | 2360 |
| | | Full-extension boom 全伸主臂 | kN·m | 1254 |
| | | Full-extension boom + jib 全伸主臂 + 副臂 | kN·m | 554 |
| | Boom length 臂长 | Basic boom 基本臂 | m | 12.2 |
| | | Full-extension boom 全伸主臂 | m | 47 |
| | | Full-extension boom + jib 全伸主臂 + 副臂 | m | 63.5 |
| | Max.lifting height 最大起重高度 | Basic boom 基本臂 | m | 12.7 |
| | | Full-extension boom 全伸主臂 | m | 47.5 |
| | | Full-extension boom + jib 全伸主臂 + 副臂 | m | 63.5 |
| Outrigger span (Longitudinal × Transverse) 支腿跨距 (纵 × 横) | m | 7.5 × 7.4 | | |
| Jib offset 副臂安装角度 | ° | 0, 15, 30 | | |
| AIRCONDITIONER 空调 | In operator's cab 上车空调 | - | Heating & cooling 制冷、制热 | |

Technical Specification

整机参数



Hook 吊钩

| Rated load 额载 /t | Number of sheaves 滑轮数量 | Rope rate 倍率 | Hook weight/kg 吊钩重量 |
|------------------|------------------------|--------------|---------------------|
| 70 | 6 | 12 | 720 |
| 8 | - | 1 | 160 |



Operations 主要动作参数

| Item 项目 | Max.single rope lifting speed (empty load) 单绳速度 (空载) | Rope diameter/length 钢丝绳直径 / 长度 | Max. single line pull 最大单绳拉力 |
|--|--|------------------------------------|---------------------------------|
| Main winch 主卷扬 | 145m/min | Φ19mm/230m | 6.6t |
| Auxiliary winch 副卷扬 | 145m/min | Φ19mm/135m | 6.6t |
| Slewing speed 回转速度 | 2r/min | | |
| Full luffing up/down time of boom 主臂起落幅时间 | 70s/80s | | |
| Full extension/retraction time of boom 主臂伸缩时间 | 95s/110s | | |
| Outrigger jack 垂直支腿 | Extend 伸 | 35s | |
| | Retract 缩 | 40s | |
| Outrigger beam 水平支腿 | Extend 伸 | 30s | |
| | Retract 缩 | 35s | |

Crane Introduction

整机介绍

Carrier 下车

Carrier frame 车架

- Double longitudinal beam construction welded by high strength steel plate, higher bearing capacity.
- 车架为高强度钢板焊接而成的双纵梁结构，承载能力强。

Engine 发动机

- Model: QSB6.7 inline six cylinder, direct injection diesel, 4 cycle, turbo charged and after cooled.
- Rated Power: 178kW/2200rpm.
- Emission standard: stage III.
- Fuel reservoir capacity: 350L.
- 型号: QSB6.7 直列六缸、水冷却、增压中冷、4 冲程循环、柴油发动机。
- 额定功率: 178kW/2200rpm。
- 排放标准: 符合 III 阶段。
- 油箱容积: 350L。

Transmission 变速箱

- DANA automatic gearbox, 6 forward and 6 reverse speeds (3 speeds high and 3 speed low).
- 德纳自动变速箱，6 个前进挡，6 个后退挡，（3 挡高速，3 挡低速）。

Axle 车桥

- Front Axle: Drive/steer with differential and planetary reduction, service and parking brake.
- Rear Axle: Drive/steer axle with differential and planetary reduction, service brake.
- 前桥: 驱动转向，行星减速机，配有轮间差速锁，行车和驻车制动。
- 后桥: 驱动转向，行星减速机，配有轮间差速锁，行车制动。

Suspension system 悬挂

- Front Suspension: Rigid mounted to frame.
- Rear Suspension: Pivot mounted with hydraulic lockout device.
- 前桥刚性连接，后桥带油缸锁定枢轴摆动悬挂。

Tires 轮胎

- Bias ply tires sized 29.5-25.
- 29.5-25 斜交胎。

Brake 制动系统

- Full hydraulic double-circuit brake system. Service brake on all wheels, parking brake on front wheels.
- 双回路液压制动，行车制动作用于前后轮，驻车制动作用于前轮。

Outrigger 支腿

- H-type telescoping outrigger, 4-point support, with span (longitudinal × transverse) 7.5m × 7.4m.
- 采用 H 形伸缩支腿，4 点支撑，纵、横跨距 7.5m × 7.4m。

Steering 转向系统

- Full hydraulic independent power steering. Steering type: front wheel, rear wheel, four wheel and crab.
- 独立液压助力转向，四种转向模式：前轮，后轮，全轮，蟹型。

Crane Introduction

整机介绍

superstructure 上车

Operator's cab 操纵室

- New generation T-series operator's cab features curved-rail sliding door, safety glass and corrosion resistant steel construction with softened interior trim. Large internal space with panoramic skylight, adjustable seat and other user-friendly design incl. A/C, electric wiper, making it more comfortable and easier to work. The LMI screen is equipped to realize the logic integration of the control console and the display, so that all working data can be seen at a glance.
- 全新一代 T 系列操纵室，带变轨滑移门，配备安全玻璃，耐腐蚀钢板，配置软化内饰、超大内部空间、可调式座椅等人性化设计，配有空调、电动雨刮器，操作更舒适、轻松；配置力矩限制器显示屏，实现主控台与操作显示系统有机结合，使吊装作业的全部工况数据一目了然。

Boom system 臂架系统

- Boom: Five-section, basic boom 12.2m, full-extension 47m, made of high-strength welded structural steel with U-shape cross-section.
- Jib: Two-stage, 9.2m/16m, offset at 0°, 15°, 30°.
- 主臂：五节臂，基本臂 12.2m，全伸臂 47m，由高强度焊接结构钢制成，U 形截面。
- 副臂：两节副臂，分别为 9.2m 和 16m，安装角度为 0°，15°，30°。

Slewing platform 转台结构

- SANY independently developed, made of fine grain high strength steel in optimized structure.
- 三一自主设计，结构更优化，由细晶粒高强度钢制成。

Hydraulics 液压系统

- Load sensing variable piston pump can adjust displacement in real time to achieve high precision flow control, greatly reducing energy loss.
- Winch adopts electronically controlled variable motor with high operation efficiency. Max. single rope speed of main winch is 145m/min, and auxiliary winch 145m/min.
- Slewing system integrating slewing buffer and free swing technology, start & brake process is smoother and the inching motion performance is ever better.
- 采用负载敏感变量柱塞泵，能实时调节油泵排量，实现高精度的流量控制，极大的降低能量损耗。
- 卷扬采用电控变量马达，作业效率高；主卷扬单绳速度最大达 145m/min，副卷扬单绳速度最大达 145m/min。
- 回转系统带集成回转缓冲阀，具有自由滑转功能，回转启动和控制平稳，微动性卓越。

Hoist 起升机构

- Main winch and aux. winch adopt planetary reduction with variable displacement motor, featuring high speed and low speed control. Non-rotation high strength wire rope is used.
- 主副卷扬采用行星减速机和变量马达，分高低速控制。配备防旋转高强度钢丝绳。

Low temperature package 低温装置

- Low-temp steel, low-temp cylinders, low-temp seals, engine water-cooled heater, transmission heater, battery heater, double independent heaters for operator's cab, -40°C grease, antifreeze, and hydraulic oil heater are applied to ensure well-functioning in bitterly cold temperatures.
- 低温钢、低温油缸、低温密封件、发动机水冷加热器，变速箱加热，电池加热；操纵室主副独立加热器，-40°C 低温油脂，低温防冻液，液压油箱加热器。

Luffing system 变幅系统

- Double acting single rod hydraulic cylinder with holding valve, luffing angle: -2°~80°. Passive luffing down, reducing energy consumption, improving luffing stability.
- 双作用单活塞杆液压缸，带安全平衡阀，变幅角度：-2°~80°，采用自重落幅系统，降低能耗，提高落幅操作的平稳性。

Slewing 回转系统

- 360° slewing in both directions, max. speed 2r/min. It adopts hydro proportional speed control for stable movement and system reliability. Slewing balance valve fitted to ensure smooth braking.
- 360° 转动，最大回转速度 2r/min。液控比例调速控制，动作稳定，系统可靠。回转缓冲设计，制动更平稳。

Counterweight 配重

- Fixed block 7.6t.
- 固定配重 7.6t。

Safety equipment 安全装置

- Load moment indicator: Analytical mechanics is applied and moment limiter calculation system based on the hoisting mechanics model is established. Through online empty-load calibration, the rated accuracy can reach 0-5% to fully protect the hoisting operation. In case of overload, the system will automatically give an alarm to guarantee safety operation.
- The hydraulic system includes balance valve, relief valve, and two-way holding valve to realize system stability and reliability.
- The main and auxiliary winches are equipped with third-wrap indicators to prevent over-hoist-down of the wire rope.
- Boom head and jib head are equipped with A2B switches to prevent the wire rope from over winding.
- The length & angle sensor and pressure sensor are equipped to signify working status in real time, automatically stopping hazardous actions with buzzer alarm.
- 力矩限制器：采用分析力学方法，建立了基于吊重力学模型的力矩限制器计算系统，通过在线空载标定，额定吊重精度达到 0-5%，全方位保护吊载作业；超载作业时，系统自动报警提示，为操纵作业提供安全保障。
- 液压系统配置平衡阀、溢流阀、双向液压锁等元件，实现液压系统稳定可靠。
- 主、副卷扬配置三圈保护器，防止钢丝绳过放。
- 主、副臂端配置高度限位器，防止钢丝绳过卷。
- 配置长度角度传感器、压力传感器，实时显示起重机作业状态，自动切断危险动作，蜂鸣报警。

Optional equipment at extra fees 选配

- Anemometer / Boom tip camera / Reversing radar / Air intake shutoff valve / Spark arrester / Slewing buzzer / Navigation beacon / Desert tires / Inflator / Customized painting.
- Other equipment available upon request.
- 风速仪 / 臂头摄像头 / 倒车雷达 / 进气切断阀 / 火星灭火器 / 回转蜂鸣器 / 航标灯 / 沙漠胎 / 打气泵 / 特殊涂装。
- 其他选配视需求定。

Working Conditions

工况组合



Telescopic boom on outriggers
主臂、支腿吊载

Fixed jib on outriggers
固定副臂、支腿吊载

Telescopic boom on tires
主臂、轮胎吊载

Operating Range - Telescopic Boom

起升高度曲线 - 主臂

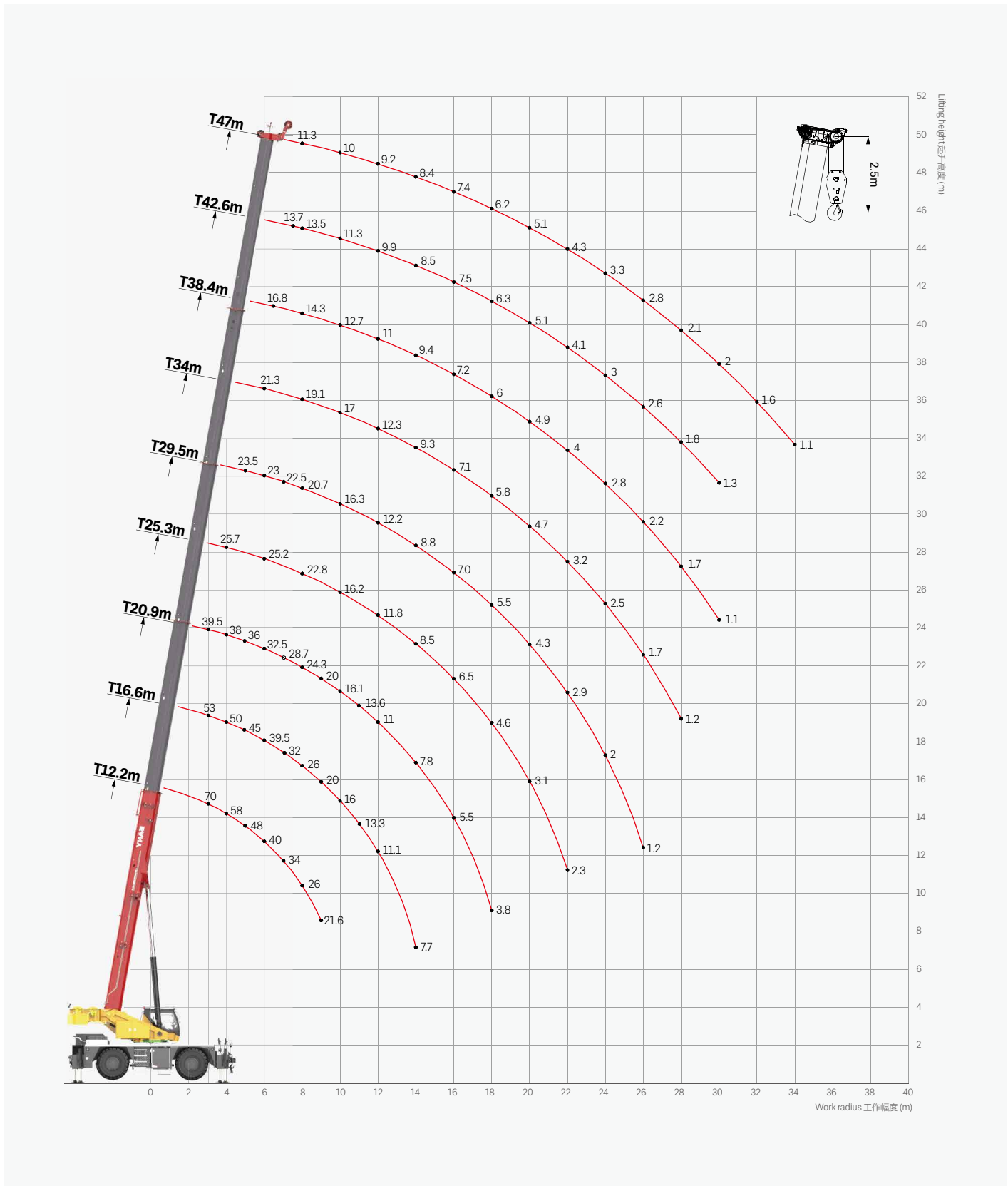









Load Chart-Telescopic Boom

性能表 - 主臂

Unit: kg











|  | 12.2 | 16.6 | 20.8 | 25.3 | 29.7 | 33.9 | 38.3 | 16.6 | 21.0 | 25.2 |  |
|---|-------|-------|-------|-------|-------|-------|-------|-------|-------|-------|---|
| 3.0 | 70000 | 30000 | 27500 | | | | | 53000 | 29100 | | 3.0 |
| 3.5 | 65000 | 29500 | 27000 | | | | | 51500 | 28800 | | 3.5 |
| 4.0 | 58000 | 29000 | 26500 | 24000 | | | | 50000 | 28200 | 24800 | 4.0 |
| 4.5 | 53000 | 28500 | 26000 | 23500 | | | | 48000 | 27500 | 24800 | 4.5 |
| 5.0 | 48000 | 28000 | 25500 | 23000 | 18800 | | | 45000 | 27000 | 24800 | 5.0 |
| 5.5 | 43800 | 27500 | 25000 | 22500 | 18500 | | | 42500 | 26500 | 24800 | 5.5 |
| 6.0 | 40000 | 27000 | 24500 | 22000 | 18000 | 17400 | | 39500 | 26000 | 24800 | 6.0 |
| 6.5 | 36800 | 26400 | 24000 | 21500 | 17800 | 17200 | 12500 | 35500 | 25500 | 24000 | 6.5 |
| 7.0 | 34000 | 26000 | 23500 | 21000 | 17200 | 16800 | 12300 | 32000 | 25000 | 23600 | 7.0 |
| 7.5 | 31700 | 25000 | 23000 | 20500 | 16800 | 16200 | 12100 | 29000 | 24200 | 22500 | 7.5 |
| 8.0 | 26000 | 23600 | 22000 | 20000 | 16200 | 16000 | 11800 | 26000 | 22800 | 21500 | 8.0 |
| 9.0 | 21600 | 21000 | 20500 | 19800 | 15000 | 14800 | 11500 | 20000 | 20500 | 20700 | 9.0 |
| 10.0 | | 18500 | 19200 | 18500 | 13800 | 13600 | 11000 | 16000 | 17200 | 17900 | 10.0 |
| 11.0 | | 15700 | 16600 | 16200 | 12800 | 12600 | 10200 | 13300 | 14800 | 15200 | 11.0 |
| 12.0 | | 13200 | 14200 | 14000 | 11800 | 11500 | 9600 | 11100 | 12400 | 12800 | 12.0 |
| 14.0 | | 9800 | 10500 | 11200 | 10500 | 10500 | 8900 | 7700 | 8300 | 9600 | 14.0 |
| 16.0 | | | 8300 | 8600 | 8700 | 8500 | 7900 | | 6000 | 7000 | 16.0 |
| 18.0 | | | 6500 | 6800 | 6900 | 7000 | 6700 | | 4200 | 5000 | 18.0 |
| 20.0 | | | | 5500 | 5800 | 6000 | 6000 | | | 3800 | 20.0 |
| 22.0 | | | | 4400 | 4600 | 5100 | 5100 | | | 2600 | 22.0 |
| 24.0 | | | | | 3800 | 4300 | 4300 | | | | 24.0 |
| 26.0 | | | | | 3200 | 3400 | 3700 | | | | 26.0 |
| 28.0 | | | | | | 2900 | 3000 | | | | 28.0 |
| 30.0 | | | | | | 2200 | 2300 | | | | 30.0 |
| 32.0 | | | | | | | 1900 | | | | 32.0 |
| 34.0 | | | | | | | 1500 | | | | 34.0 |
| 36.0 | | | | | | | 1100 | | | | 36.0 |
|  | 12 | 6 | 6 | 4 | 4 | 4 | 4 | 10 | 6 | 4 |  |
|  | 2# | 0 | 0 | 0 | 0 | 0 | 0 | 50 | 50 | 50 | 2# |
| | 3# | 0 | 17 | 33 | 50 | 67 | 83 | 100 | 0 | 17 | 33 |
| | 4# | 0 | 17 | 33 | 50 | 67 | 83 | 100 | 0 | 17 | 33 |
| | 5# | 0 | 17 | 33 | 50 | 67 | 83 | 100 | 0 | 17 | 33 |
|  | 0 | 0 | 0 | 0 | 0 | 0 | 0 | 0 | 0 | 0 |  |
|  | 18000 | 8000 | 6000 | 4500 | 2500 | 1500 | 1000 | 9000 | 4500 | 3500 |  |

Load Chart-Telescopic Boom

性能表 - 主臂

Unit: kg











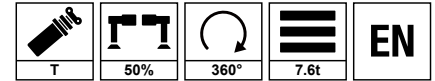









|  m | 29.6 | 34.0 | 38.2 | 42.7 | 20.9 | 25.3 | 29.5 | 34.0 | 38.4 | 42.6 | 47.0 |  m | |
|---|-------|-------|-------|-------|-------|-------|-------|-------|-------|-------|-------|---|----|
| 3.0 | | | | | 39500 | | | | | | | 3.0 | |
| 3.5 | | | | | 39000 | | | | | | | 3.5 | |
| 4.0 | | | | | 38000 | 25700 | | | | | | 4.0 | |
| 4.5 | | | | | 37000 | 25600 | | | | | | 4.5 | |
| 5.0 | 23300 | | | | 36000 | 25500 | 23500 | | | | | 5.0 | |
| 5.5 | 23100 | | | | 34000 | 25400 | 23300 | | | | | 5.5 | |
| 6.0 | 22500 | 17900 | | | 32500 | 25200 | 23000 | 21300 | | | | 6.0 | |
| 6.5 | 22000 | 17600 | 15300 | | 30500 | 25000 | 22800 | 21000 | 16800 | | | 6.5 | |
| 7.0 | 21500 | 17200 | 15000 | | 28700 | 24500 | 22500 | 20500 | 16500 | | | 7.0 | |
| 7.5 | 21200 | 17000 | 14400 | 12200 | 26800 | 24000 | 22000 | 19800 | 15400 | 13700 | | 7.5 | |
| 8.0 | 21000 | 16500 | 13800 | 12000 | 24300 | 22800 | 20700 | 19100 | 14300 | 13500 | 11300 | 8.0 | |
| 9.0 | 20600 | 15000 | 12600 | 11500 | 20000 | 18800 | 18500 | 18300 | 13200 | 12400 | 11000 | 9.0 | |
| 10.0 | 17000 | 14000 | 11500 | 11000 | 16100 | 16200 | 16300 | 17000 | 12700 | 11300 | 10000 | 10.0 | |
| 11.0 | 14600 | 13000 | 11000 | 10800 | 13600 | 13700 | 13900 | 14300 | 11600 | 10700 | 9600 | 11.0 | |
| 12.0 | 13000 | 12000 | 10600 | 10400 | 11100 | 11800 | 12200 | 12300 | 11000 | 9900 | 9200 | 12.0 | |
| 14.0 | 9800 | 10400 | 9200 | 9000 | 7800 | 8500 | 8800 | 9300 | 9400 | 8500 | 8400 | 14.0 | |
| 16.0 | 7700 | 8200 | 8000 | 7800 | 5500 | 6500 | 7000 | 7100 | 7200 | 7500 | 7400 | 16.0 | |
| 18.0 | 6300 | 6400 | 6500 | 6500 | 3800 | 4600 | 5500 | 5800 | 6000 | 6300 | 6200 | 18.0 | |
| 20.0 | 4800 | 5300 | 5400 | 5600 | | 3100 | 4300 | 4700 | 4900 | 5100 | 5100 | 20.0 | |
| 22.0 | 3700 | 4400 | 4500 | 4700 | | 2300 | 2900 | 3200 | 4000 | 4100 | 4300 | 22.0 | |
| 24.0 | 2800 | 3500 | 3700 | 3900 | | | 2000 | 2500 | 2800 | 3000 | 3300 | 24.0 | |
| 26.0 | 2000 | 2800 | 2900 | 3200 | | | 1200 | 1700 | 2200 | 2600 | 2800 | 26.0 | |
| 28.0 | | 2300 | 2500 | 2600 | | | | 1200 | 1700 | 1800 | 2100 | 28.0 | |
| 30.0 | | 1600 | 2000 | 2100 | | | | | 1100 | 1300 | 1600 | 30.0 | |
| 32.0 | | | 1500 | 1600 | | | | | | | 1100 | 32.0 | |
| 34.0 | | | 1000 | 1200 | | | | | | | | 34.0 | |
|  | 4 | 4 | 4 | 4 | 8 | 4 | 4 | 4 | 4 | 3 | 3 |  | |
|  | 2# | 50 | 50 | 50 | 50 | 100 | 100 | 100 | 100 | 100 | 100 | 2# | |
| | 3# | 50 | 67 | 83 | 100 | 0 | 17 | 33 | 50 | 67 | 83 | 100 | 3# |
| | 4# | 50 | 67 | 83 | 100 | 0 | 17 | 33 | 50 | 67 | 83 | 100 | 4# |
| | 5# | 50 | 67 | 83 | 100 | 0 | 17 | 33 | 50 | 67 | 83 | 100 | 5# |
|  | 0 | 0 | 18 | 31 | 0 | 0 | 0 | 26 | 32 | 40 | 42 |  | |
|  | 2000 | 1000 | 1000 | 800 | 4000 | 2000 | 1500 | 800 | 800 | 800 | 800 |  | |

Load Chart-Telescopic Boom

性能表 - 主臂

Unit: kg

















|  m | 12.2 | 16.6 | 20.8 | 25.3 | 29.7 | 33.9 | 38.3 | 16.6 | 21.0 | 25.2 |  m |
|--|-------|-------|-------|-------|-------|-------|-------|-------|-------|-------|--|
| 3.0 | 58000 | 26000 | 23500 | | | | | 43000 | 24500 | | 3.0 |
| 3.5 | 52000 | 25000 | 23100 | | | | | 41000 | 24000 | | 3.5 |
| 4.0 | 48000 | 23000 | 22000 | 21000 | | | | 39000 | 23000 | 21500 | 4.0 |
| 4.5 | 43000 | 22000 | 21000 | 20500 | | | | 35000 | 22000 | 21000 | 4.5 |
| 5.0 | 35000 | 21000 | 20000 | 19000 | 17100 | | | 29000 | 21000 | 20500 | 5.0 |
| 5.5 | 29000 | 20000 | 18900 | 17900 | 16000 | | | 25000 | 20000 | 19500 | 5.5 |
| 6.0 | 24500 | 19000 | 17800 | 16800 | 15000 | 15600 | | 21500 | 19000 | 18500 | 6.0 |
| 6.5 | 21000 | 17800 | 16800 | 15700 | 14000 | 13700 | 11500 | 18800 | 17500 | 17000 | 6.5 |
| 7.0 | 18200 | 16500 | 15800 | 14700 | 13500 | 12500 | 11300 | 16500 | 15800 | 15700 | 7.0 |
| 7.5 | 16000 | 15500 | 14700 | 13800 | 12600 | 11500 | 11000 | 14700 | 14500 | 14300 | 7.5 |
| 8.0 | 13500 | 14200 | 13700 | 13100 | 12000 | 10700 | 10500 | 12900 | 13000 | 13300 | 8.0 |
| 9.0 | 10800 | 11800 | 11700 | 11600 | 10600 | 10000 | 9500 | 10000 | 10500 | 11000 | 9.0 |
| 10.0 | | 9900 | 10000 | 9900 | 9600 | 8700 | 8500 | 8000 | 8700 | 9200 | 10.0 |
| 11.0 | | 7700 | 8200 | 8400 | 8300 | 8100 | 8000 | 6000 | 7300 | 7800 | 11.0 |
| 12.0 | | 6200 | 7000 | 7200 | 7500 | 7400 | 7300 | 4700 | 6100 | 6800 | 12.0 |
| 14.0 | | 4000 | 5200 | 5500 | 5600 | 6000 | 5800 | | 4200 | 4800 | 14.0 |
| 16.0 | | | 4000 | 4200 | 4400 | 4900 | 4700 | | 2900 | 3500 | 16.0 |
| 18.0 | | | | 3000 | 3400 | 3800 | 3600 | | | 2500 | 18.0 |
| 20.0 | | | | 2000 | 2300 | 2900 | 2800 | | | 1800 | 20.0 |
| 22.0 | | | | | 1700 | 2100 | 2200 | | | | 22.0 |
| 24.0 | | | | | 1200 | 1600 | 1700 | | | | 24.0 |
| 26.0 | | | | | | 1100 | 1200 | | | | 26.0 |
|  T _n | 10 | 4 | 4 | 4 | 4 | 4 | 4 | 8 | 4 | 4 |  T _n |
|  2# | 0 | 0 | 0 | 0 | 0 | 0 | 0 | 50 | 50 | 50 |  2# |
|  3# | 0 | 17 | 33 | 50 | 67 | 83 | 100 | 0 | 17 | 33 |  3# |
|  4# | 0 | 17 | 33 | 50 | 67 | 83 | 100 | 0 | 17 | 33 |  4# |
|  5# | 0 | 17 | 33 | 50 | 67 | 83 | 100 | 0 | 17 | 33 |  5# |
|  Min | 0 | 0 | 0 | 0 | 27 | 33 | 42 | 0 | 0 | 22 |  Min |
|  Min kg | 10000 | 3500 | 2500 | 1500 | 1000 | 800 | 800 | 3500 | 1500 | 1000 |  Min kg |
|  Max | 80 | 80 | 80 | 80 | 80 | 80 | 80 | 80 | 80 | 80 |  Max |

Load Chart-Telescopic Boom

性能表 - 主臂

Unit: kg

















|  | 29.6 | 34.0 | 38.2 | 42.7 | 20.9 | 25.3 | 29.5 | 34.0 | 38.4 | 42.6 | 47.0 |  |
|---|-------|-------|-------|------|-------|-------|-------|-------|-------|-------|------|---|
| 3.0 | | | | | 34000 | | | | | | | 3.0 |
| 3.5 | | | | | 33000 | | | | | | | 3.5 |
| 4.0 | | | | | 32000 | 23000 | | | | | | 4.0 |
| 4.5 | | | | | 30000 | 22500 | | | | | | 4.5 |
| 5.0 | 20000 | | | | 27000 | 22200 | 22000 | | | | | 5.0 |
| 5.5 | 19000 | | | | 24000 | 21500 | 21000 | | | | | 5.5 |
| 6.0 | 17800 | 16500 | | | 20500 | 19500 | 19000 | 17600 | | | | 6.0 |
| 6.5 | 16800 | 14800 | 12500 | | 18000 | 17800 | 17500 | 16800 | 14900 | | | 6.5 |
| 7.0 | 15500 | 13700 | 12100 | | 16000 | 15800 | 15700 | 15500 | 14500 | | | 7.0 |
| 7.5 | 14200 | 12600 | 11500 | 9700 | 14100 | 14200 | 14300 | 14000 | 13000 | 11300 | | 7.5 |
| 8.0 | 13200 | 11600 | 11000 | 9100 | 12500 | 12900 | 13000 | 12800 | 11800 | 11000 | 8800 | 8.0 |
| 9.0 | 10900 | 10000 | 9800 | 8500 | 10000 | 10400 | 10500 | 10600 | 10000 | 9800 | 8000 | 9.0 |
| 10.0 | 9000 | 8800 | 8600 | 8000 | 8200 | 8600 | 8800 | 9000 | 8600 | 8500 | 7500 | 10.0 |
| 11.0 | 8100 | 7900 | 7800 | 7500 | 6500 | 7300 | 7400 | 7700 | 7500 | 7400 | 7000 | 11.0 |
| 12.0 | 7000 | 6800 | 6700 | 6600 | 5200 | 5800 | 6000 | 6300 | 6600 | 6500 | 6400 | 12.0 |
| 14.0 | 5000 | 5300 | 5200 | 5100 | 3100 | 3800 | 4200 | 4500 | 4600 | 5000 | 4900 | 14.0 |
| 16.0 | 3600 | 3900 | 4200 | 4100 | 1800 | 2500 | 2600 | 3300 | 3400 | 3800 | 3900 | 16.0 |
| 18.0 | 2600 | 2800 | 3300 | 3200 | | 1600 | 1800 | 2200 | 2400 | 2600 | 2800 | 18.0 |
| 20.0 | 1900 | 2200 | 2300 | 2400 | | 1000 | 1200 | 1600 | 1800 | 1900 | 2000 | 20.0 |
| 22.0 | 1200 | 1600 | 1700 | 1800 | | | | 1100 | 1200 | 1300 | 1600 | 22.0 |
| 24.0 | | 1100 | 1200 | 1300 | | | | | | | 1200 | 24.0 |
| 26.0 | | | | 1000 | | | | | | | | 26.0 |
|  | 4 | 4 | 4 | 4 | 6 | 4 | 4 | 4 | 4 | 3 | 3 |  |
|  | 2# | 50 | 50 | 50 | 100 | 100 | 100 | 100 | 100 | 100 | 100 | 2# |
|  | 3# | 50 | 67 | 83 | 100 | 0 | 17 | 33 | 50 | 67 | 83 | 3# |
|  | 4# | 50 | 67 | 83 | 100 | 0 | 17 | 33 | 50 | 67 | 83 | 4# |
|  | 5# | 50 | 67 | 83 | 100 | 0 | 17 | 33 | 50 | 67 | 83 | 5# |
|  | 35 | 39 | 46 | 48 | 0 | 28 | 41 | 44 | 50 | 54 | 55 |  |
|  | 800 | 800 | 800 | 800 | 1000 | 800 | 800 | 800 | 800 | 800 | 800 |  |
|  | 80 | 80 | 80 | 80 | 80 | 80 | 80 | 80 | 80 | 80 | 80 |  |

Load Chart-Telescopic Boom

性能表 - 主臂

Unit: kg

















|  m | 12.2 | 16.6 | 20.8 | 25.3 | 29.7 | 33.9 | 38.3 | 16.6 | 21.0 | 25.2 |  m |
|--|-------|-------|-------|-------|-------|-------|-------|-------|-------|-------|--|
| 3.0 | 37000 | 22700 | 21500 | | | | | 31500 | 22500 | | 3.0 |
| 3.5 | 26500 | 21600 | 20000 | | | | | 23800 | 21000 | | 3.5 |
| 4.0 | 20000 | 19800 | 19200 | 19000 | | | | 19000 | 19200 | 19500 | 4.0 |
| 4.5 | 15500 | 17500 | 17000 | 16500 | | | | 16000 | 16300 | 16500 | 4.5 |
| 5.0 | 12500 | 15000 | 14800 | 14500 | 15000 | | | 13500 | 13600 | 13800 | 5.0 |
| 5.5 | 10200 | 12500 | 13100 | 13000 | 12900 | | | 11500 | 11600 | 11800 | 5.5 |
| 6.0 | 8500 | 11300 | 11400 | 11500 | 11600 | 11800 | | 10000 | 10500 | 10800 | 6.0 |
| 6.5 | 7000 | 9800 | 10200 | 10300 | 10400 | 10500 | 10500 | 8300 | 8900 | 9100 | 6.5 |
| 7.0 | 5000 | 8700 | 9000 | 9200 | 9300 | 9600 | 9700 | 6800 | 7500 | 7600 | 7.0 |
| 7.5 | 3400 | 7600 | 8000 | 8200 | 8400 | 8700 | 8800 | 5500 | 6000 | 6100 | 7.5 |
| 8.0 | 2200 | 6500 | 7000 | 7200 | 7500 | 8000 | 8100 | 4300 | 5200 | 5400 | 8.0 |
| 9.0 | 1300 | 5000 | 5600 | 5900 | 6100 | 6500 | 6600 | 3200 | 3900 | 4000 | 9.0 |
| 10.0 | | 3800 | 4300 | 4500 | 5000 | 5400 | 5500 | 2400 | 2700 | 2800 | 10.0 |
| 11.0 | | 3000 | 3500 | 3600 | 4200 | 4500 | 4600 | 1600 | 2100 | 2300 | 11.0 |
| 12.0 | | 2300 | 2400 | 2500 | 3400 | 3700 | 3800 | 1000 | 1700 | 1700 | 12.0 |
| 14.0 | | 1400 | 1600 | 1800 | 2400 | 2600 | 2700 | | | 1100 | 14.0 |
| 16.0 | | | 1000 | 1100 | 1700 | 2000 | 2000 | | | | 16.0 |
| 18.0 | | | | | 1100 | 1300 | 1400 | | | | 18.0 |
|  | 8 | 6 | 4 | 4 | 4 | 4 | 4 | 6 | 4 | 4 |  |
|  2# | 0 | 0 | 0 | 0 | 0 | 0 | 0 | 50 | 50 | 50 | 2# |
|  3# | 0 | 17 | 33 | 50 | 67 | 83 | 100 | 0 | 17 | 33 | 3# |
|  4# | 0 | 17 | 33 | 50 | 67 | 83 | 100 | 0 | 17 | 33 | 4# |
|  5# | 0 | 17 | 33 | 50 | 67 | 83 | 100 | 0 | 17 | 33 | 5# |
|  Min Max | 0 | 0 | 29 | 43 | 47 | 53 | 57 | 32 | 47 | 50 |  Min Max |
|  Min Max kg | 3000 | 1000 | 800 | 800 | 800 | 800 | 800 | 800 | 800 | 800 |  Min Max kg |
|  Min Max | 76 | 78 | 80 | 80 | 80 | 80 | 80 | 80 | 80 | 80 |  Min Max |

Load Chart-Telescopic Boom

性能表 - 主臂

Unit: kg



|  m | 29.6 | 34.0 | 38.2 | 42.7 | 20.9 | 25.3 | 29.5 | 34.0 | 38.4 | 42.6 | 47.0 |  m |
|---|-------|-------|-------|------|-------|-------|-------|-------|------|------|------|---|
| 3.0 | | | | | 27500 | | | | | | | 3.0 |
| 3.5 | | | | | 23000 | | | | | | | 3.5 |
| 4.0 | | | | | 21000 | 20500 | | | | | | 4.0 |
| 4.5 | | | | | 16200 | 16000 | | | | | | 4.5 |
| 5.0 | 14000 | | | | 12300 | 12600 | 13000 | | | | | 5.0 |
| 5.5 | 12000 | | | | 10000 | 10500 | 11500 | | | | | 5.5 |
| 6.0 | 11000 | 11300 | | | 8000 | 8800 | 10000 | 10800 | | | | 6.0 |
| 6.5 | 9300 | 9500 | 10000 | | 6400 | 6500 | 9000 | 9300 | 9500 | | | 6.5 |
| 7.0 | 8000 | 8200 | 8500 | | 4800 | 5500 | 7600 | 8000 | 8200 | | | 7.0 |
| 7.5 | 6500 | 6700 | 7000 | 7300 | 3800 | 4500 | 6200 | 6700 | 7000 | 7500 | | 7.5 |
| 8.0 | 5600 | 5700 | 5800 | 6000 | 3000 | 3800 | 5000 | 5200 | 5400 | 5600 | 5800 | 8.0 |
| 9.0 | 4300 | 4400 | 4500 | 4700 | 2000 | 2800 | 3200 | 3600 | 3800 | 4000 | 4200 | 9.0 |
| 10.0 | 2900 | 3000 | 3600 | 3800 | 1300 | 2000 | 2300 | 2600 | 2800 | 3000 | 3200 | 10.0 |
| 11.0 | 2400 | 2700 | 3000 | 3100 | | 1300 | 1600 | 1800 | 2100 | 2300 | 2600 | 11.0 |
| 12.0 | 1800 | 1800 | 2000 | 2500 | | | 1200 | 1400 | 1600 | 1900 | 2200 | 12.0 |
| 14.0 | 1100 | 1200 | 1200 | 1400 | | | | | | 1300 | 1400 | 14.0 |
| 16.0 | | | | 1000 | | | | | | | | 16.0 |
| 18.0 | | | | | | | | | | | | 18.0 |
|  | 4 | 4 | 4 | 4 | 6 | 4 | 4 | 4 | 4 | 3 | 3 |  |
|  | 50 | 50 | 50 | 50 | 100 | 100 | 100 | 100 | 100 | 100 | 100 | 2# |
|  | 50 | 67 | 83 | 100 | 0 | 17 | 33 | 50 | 67 | 83 | 100 | 3# |
|  | 50 | 67 | 83 | 100 | 0 | 17 | 33 | 50 | 67 | 83 | 100 | 4# |
|  | 50 | 67 | 83 | 100 | 0 | 17 | 33 | 50 | 67 | 83 | 100 | 5# |
|  | 56 | 57 | 64 | 64 | 54 | 58 | 61 | 65 | 67 | 67 | 69 |  |
|  | 800 | 800 | 800 | 800 | 800 | 800 | 800 | 800 | 800 | 800 | 800 |  |
|  | 80 | 80 | 80 | 80 | 80 | 80 | 80 | 80 | 80 | 80 | 80 |  |

Operating Range - Fixed Jib

起升高度曲线 - 副臂

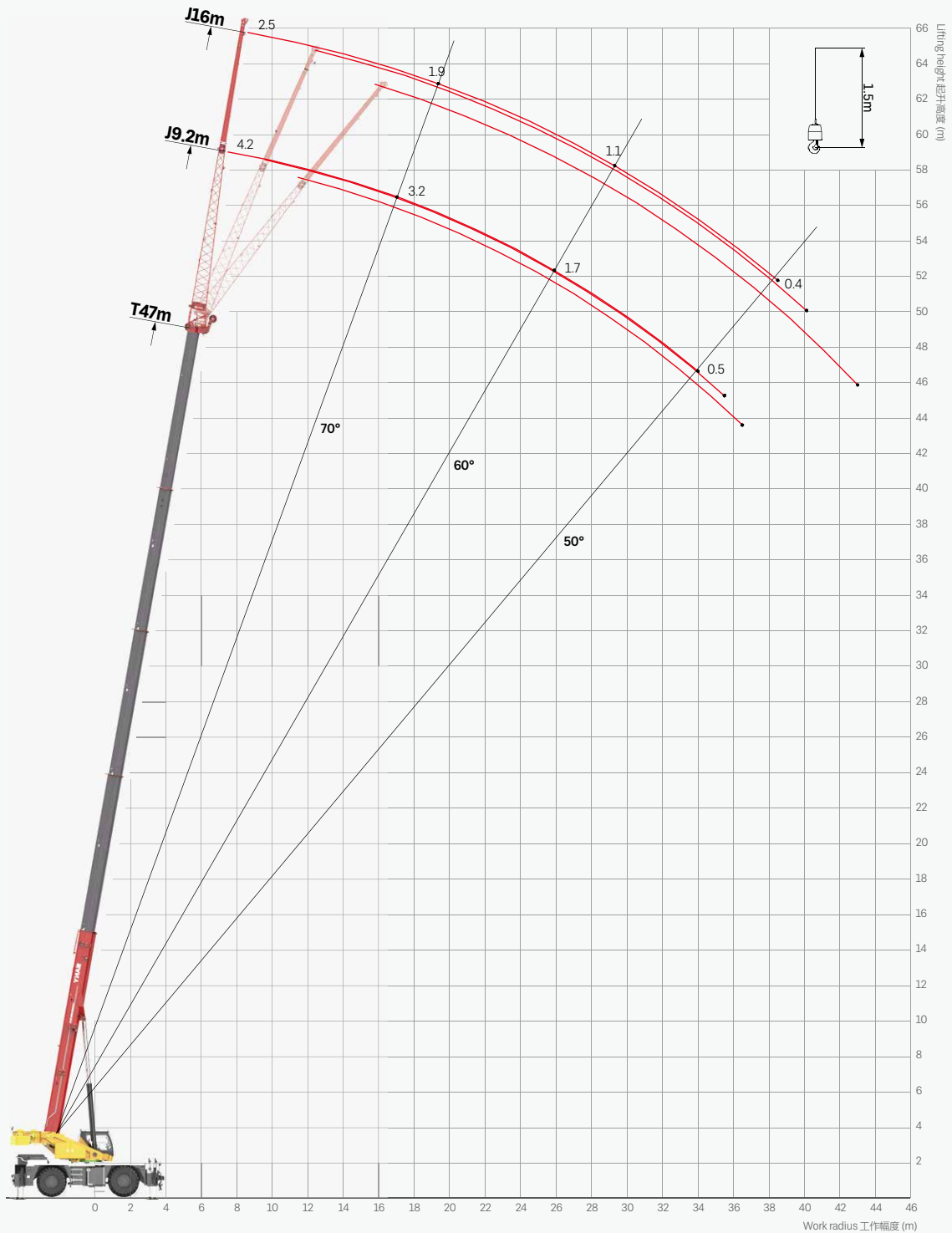

Load Chart - Fixed Jib

性能表 - 副臂

Unit: kg

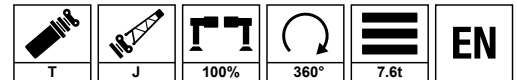















| | 47.0m + 9.0m | | | 47.0m + 16.0m | | | |
|----|--------------|------|------|---------------|------|------|----|
| | 0° | 15° | 30° | 0° | 15° | 30° | |
| 80 | 4200 | 2800 | 2500 | 2500 | 1600 | 1200 | 80 |
| 78 | 4100 | 2700 | 2400 | 2400 | 1600 | 1200 | 78 |
| 76 | 4000 | 2600 | 2400 | 2300 | 1500 | 1150 | 76 |
| 74 | 3850 | 2500 | 2300 | 2200 | 1400 | 1100 | 74 |
| 72 | 3600 | 2300 | 2200 | 2100 | 1300 | 1050 | 72 |
| 70 | 3200 | 2200 | 2100 | 1900 | 1200 | 1000 | 70 |
| 68 | 3000 | 2000 | 2000 | 1700 | 1150 | 950 | 68 |
| 66 | 2600 | 1900 | 1900 | 1500 | 1100 | 900 | 66 |
| 64 | 2300 | 1800 | 1800 | 1400 | 1050 | 850 | 64 |
| 62 | 2000 | 1700 | 1500 | 1300 | 1000 | 800 | 62 |
| 60 | 1700 | 1500 | 1200 | 1100 | 900 | 750 | 60 |
| 58 | 1300 | 1100 | 900 | 950 | 800 | 650 | 58 |
| 56 | 1100 | 1000 | 800 | 850 | 750 | 600 | 56 |
| 54 | 800 | 750 | 650 | 700 | 600 | 500 | 54 |
| 52 | 700 | 700 | 600 | 550 | 550 | 400 | 52 |
| 50 | 500 | 500 | 450 | 400 | 350 | 300 | 50 |
| | 1 | | | | | | |
| | 48 | | | | | | |
| | 350 | 300 | 250 | 250 | 200 | 200 | |

Load Chart - Telescopic Boom, On Tires Stationary, Load Over Front

性能表 - 轮胎静止吊载 (正前方)

Unit: kg













|  m | 12.2 | 16.6 | 20.8 | 25.3 | 29.7 |  m | |
|---|-------|-------|-------|-------|-------|---|--|
| 3.0 | 21000 | 17000 | 16000 | | | 3.0 | |
| 3.5 | 19200 | 16000 | 15000 | | | 3.5 | |
| 4.0 | 17300 | 15000 | 14000 | 13000 | | 4.0 | |
| 4.5 | 15500 | 14000 | 13000 | 12000 | | 4.5 | |
| 5.0 | 14000 | 12500 | 12000 | 11300 | 11000 | 5.0 | |
| 5.5 | 11800 | 11000 | 10700 | 10300 | 10000 | 5.5 | |
| 6.0 | 9900 | 10000 | 9800 | 9700 | 9500 | 6.0 | |
| 6.5 | 8400 | 8800 | 9000 | 8800 | 8700 | 6.5 | |
| 7.0 | 7200 | 7500 | 8000 | 7800 | 7600 | 7.0 | |
| 7.5 | 6300 | 6500 | 7000 | 6900 | 6800 | 7.5 | |
| 8.0 | 5300 | 5700 | 6400 | 6200 | 6100 | 8.0 | |
| 9.0 | 4500 | 5000 | 5200 | 5400 | 5300 | 9.0 | |
| 10.0 | | 3600 | 3900 | 4500 | 4600 | 10.0 | |
| 11.0 | | 3000 | 3200 | 3800 | 4000 | 11.0 | |
| 12.0 | | 2200 | 2300 | 3000 | 3500 | 12.0 | |
| 14.0 | | | | 2200 | 2300 | 14.0 | |
| 16.0 | | | | | | 16.0 | |
|  | 4 | 4 | 4 | 4 | 4 |  | |
|  | 2# | 0 | 0 | 0 | 0 | 2# | |
| | 3# | 0 | 17 | 33 | 50 | 67 | 3#  |
| | 4# | 0 | 17 | 33 | 50 | 67 | 4# |
| | 5# | 0 | 17 | 33 | 50 | 67 | 5# |
|  Min | 0 | 32 | 47 | 50 | 56 |  Min | |
|  Min  | 2000 | 800 | 800 | 800 | 800 |  Min  | |
|  Max | 80 | 80 | 80 | 80 | 80 |  Max | |

Load Chart - Telescopic Boom, Pick & Carry, Load Over Front

性能表 - 主臂帶載行駛 (正前方)

Unit: kg















|  m | 12.2 | 16.6 | 20.8 | 25.3 | 29.7 |  m |
|---|-------|-------|-------|-------|------|---|
| 3.0 | 18000 | 14000 | 13000 | | | 3.0 |
| 3.5 | 16000 | 13000 | 12000 | | | 3.5 |
| 4.0 | 14000 | 12000 | 11500 | 11000 | | 4.0 |
| 4.5 | 12000 | 10800 | 10400 | 10000 | | 4.5 |
| 5.0 | 10400 | 10300 | 9900 | 9500 | 9000 | 5.0 |
| 5.5 | 9000 | 9200 | 8900 | 8500 | 8000 | 5.5 |
| 6.0 | 7800 | 8000 | 7600 | 7400 | 7300 | 6.0 |
| 6.5 | 6800 | 7100 | 6800 | 6700 | 6500 | 6.5 |
| 7.0 | 6000 | 6100 | 6000 | 5900 | 5800 | 7.0 |
| 7.5 | 5200 | 5300 | 5400 | 5500 | 5400 | 7.5 |
| 8.0 | 4500 | 4700 | 4800 | 4900 | 5000 | 8.0 |
| 9.0 | 3000 | 3800 | 4000 | 4100 | 4200 | 9.0 |
| 10.0 | | 3100 | 3400 | 3500 | 4000 | 10.0 |
| 11.0 | | 2500 | 2700 | 3000 | 3500 | 11.0 |
| 12.0 | | 1800 | 2000 | 2400 | 2700 | 12.0 |
| 14.0 | | | | | | 14.0 |
|  T _n | 4 | 4 | 4 | 4 | 4 |  T _n |
|  % | 2# | 0 | 0 | 0 | 0 | 2# |
| | 3# | 0 | 17 | 33 | 50 | 67 |
| | 4# | 0 | 17 | 33 | 50 | 67 |
| | 5# | 0 | 17 | 33 | 50 | 67 |
| | | 0 | 32 | 47 | 50 | 56 |
|  Min  | 800 | 800 | 800 | 800 | 800 |  Min  |
|  Max | 80 | 80 | 80 | 80 | 80 |  Max |

Load Chart - Telescopic Boom, On Tires Stationary, 360° Slewing

性能表 - 轮胎静止吊载 (360°)



Unit: kg

|  m | 12.2 | 16.6 | 20.8 | 25.3 | 29.7 |  m |
|--|-------|-------|------|------|------|--|
| 3.0 | 12000 | | | | | 3.0 |
| 3.5 | 11000 | | | | | 3.5 |
| 4.0 | 10500 | 10000 | | | | 4.0 |
| 4.5 | 8600 | 8200 | 8000 | 6500 | | 4.5 |
| 5.0 | 7000 | 6500 | 6000 | 5600 | 5500 | 5.0 |
| 5.5 | 5800 | 5500 | 5000 | 4900 | 4800 | 5.5 |
| 6.0 | 4300 | 4200 | 4100 | 4000 | 3900 | 6.0 |
| 6.5 | 3000 | 3100 | 3200 | 3300 | 3500 | 6.5 |
| 7.0 | 2500 | 2600 | 2700 | 2800 | 3000 | 7.0 |
| 7.5 | 2000 | 2100 | 2200 | 2300 | 2500 | 7.5 |
| 8.0 | | | | | 2000 | 8.0 |
| 9.0 | | | | | | 9.0 |
|  | 4 | 4 | 4 | 4 | 4 |  |
| 2# | 0 | 0 | 0 | 0 | 0 | 2# |
|  3# | 0 | 17 | 33 | 50 | 67 | 3#  |
| 4# | 0 | 17 | 33 | 50 | 67 | 4# |
| 5# | 0 | 17 | 33 | 50 | 67 | 5# |
|  Min | 39 | 55 | 62 | 67 | 69 |  Min |
|  Min kg | 800 | 800 | 800 | 800 | 800 |  Min kg |
|  Max | 68 | 72 | 74 | 76 | 78 |  Max |

Remark

- Capacities are applicable at 525kPa cold tire inflation pressure.
- Capacities are applicable only with machine on firm level surface.
- On tire lifting with the jib mounted is not permitted.
- Axle lockouts must be applied when lifting on tires.
- Parking brake must be applied when lifting on tires stationary.
- Driving speed shall be ≤4km/h at pick & carry mode.

- 冷态轮胎气压需保持 525kPa。
- 起重机需在平整坚固的地面上作业。
- 轮胎吊载工况不允许使用副臂吊载。
- 轮胎吊载工况中，车桥悬挂需锁定。
- 轮胎静止吊载工况中，需使用驻车制动。
- 带载行驶工况中，直线行驶速度需小于等于 4km/h。



**ТЕХНИКА
СЕРВИС
ЗАПЧАСТИ**

ОФИЦИАЛЬНЫЙ ДИЛЕР

ТРАКТОРОДЕТАЛ.РУ

8 800 100-77-66

